



User manual

For appliances with a DRU Bluetooth remote control









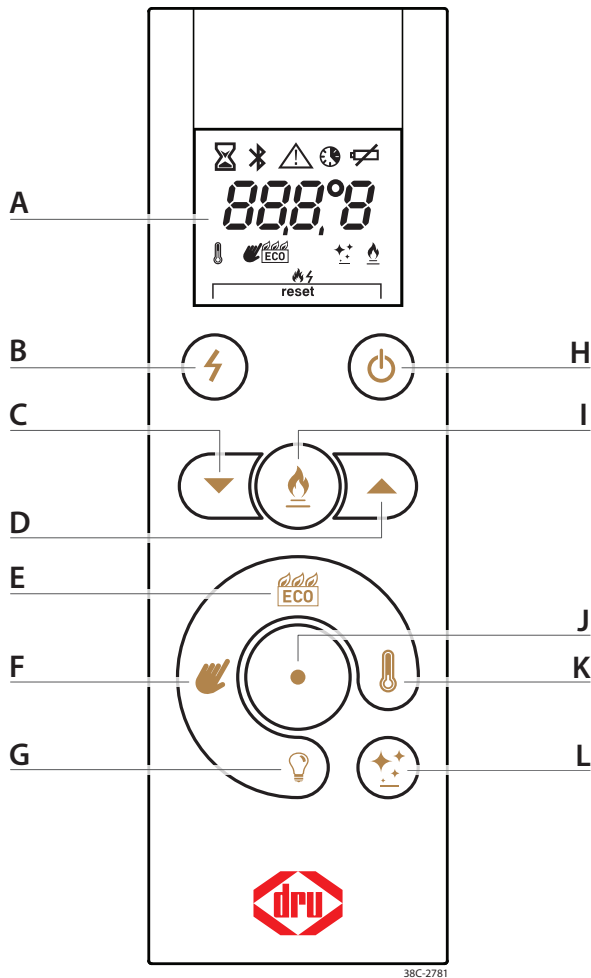



















English

Store this document in a safe place





- A** - Display
- B** - Ignition
- C** - Down
- D** - Up
- E** - Eco Wave
- F** - Manual operation
- G** - Switching power supply
- H** - Ignition / Switch off
- I** - Second burner
- J** - Function button
- K** - Thermostat
- L** - Eco Glow

Button	Display	Description
		Switching off the appliance <i>Page 19, section 4.3.5</i>
		Igniting the appliance <i>Page 19, section 4.3.6</i>
		Second burner on/off <i>Page 20, section 4.3.7</i>
		Switching on the Eco Wave <i>Page 22, section 4.3.9</i>
		Switching on manual operation <i>Page 21, section 4.3.8</i>
		Switching on the thermostat <i>Page 23, section 4.3.10</i>
		Eco Glow / Switch Contact on/off <i>Page 24, section 4.3.11</i>
		Switching power supply on/off <i>Page 24, section 4.3.12</i>
		Action in progress <i>Action is carried out</i>
		Bluetooth connection status <i>Page 14, section 4.3</i>
		Error message <i>Page 28, section 5</i>
		Time schedule on/off <i>Page 25, section 4.3.13</i>
		Replacing the batteries <i>Page 14, section 4.3.1</i>
		Temperature display <i>The currently measured room temperature</i>
		Connection lost <i>Page 28, section 5.1</i>
		Error code <i>Page 30, section 5.3</i>
		Resetting the appliance <i>Page 30, section 5.4</i>
 (5 sec.)		Bluetooth pairing mode <i>Page 18, section 4.3.4</i>

Contents

1. Introduction	5
2. Safety	6
2.1 Precautions / safety instructions	6
2.1.1 Safety of the installation	6
2.1.2 Safety of people and animals	8
2.1.3 Safety through maintenance	9
2.2 EU Declaration of Conformity	9
3. Taking the appliance in operation	10
3.1 Stoking up for the first time	10
3.2 Discolouration of walls and ceilings	11
4. Operating the appliance	12
4.1 DRU Fire App	12
4.2 Home automation	13
4.3 Remote control	14
4.3.1 Placing/replacing the batteries	14
4.3.2 Coupling the remote control	16
4.3.3 Uncoupling the remote control	18
4.3.4 Coupling the DRU Fire App	18
4.3.5 Switching off the appliance	19
4.3.6 Ignition	19
4.3.7 Switching on/off the second burner	20
4.3.8 Manual operation	21
4.3.9 Eco Wave	22
4.3.10 Thermostat	23
4.3.11 Eco Glow / Switch contact	24
4.3.12 Switching power supply	24
4.3.13 Time Schedule	25
4.3.14 Temperature display in degrees Celsius or Fahrenheit	26
4.3.15 Updating the remote control	27
5. Malfunction	28
5.1 Error message <i>LOS t</i>	28
5.2 Measuring the strength of the signal	29
5.3 Error code F/E	30
5.4 Resetting the appliance	30
6. Maintenance	31
6.1 Cleaning the glass pane(s)	32
6.1.1 Easy release door system	33
6.2 How to use DRU spray	34
6.3 How to use DRU glass pane cleaner	34
7. Environment	35
7.1 General	35
7.2 Appliance	35
8. Warranty	35
9. Technical data Remote control	35

1. Introduction

DRU, a manufacturer of gas-fired and electric stoves, develops and produces products that comply with the highest quality, performance and safety requirements. This appliance has a CE label, which means that it complies with the essential requirements of the European gas appliance directive. The appliance is supplied with an installation manual and a user manual. Installation and maintenance of the appliance must be carried out by a professional and certified expert with proven knowledge and competence, hereafter referred to as competent installer.

This user manual contains all information required to operate the appliance in a correct and safe manner. Carefully read this manual before taking the appliance in operation. Users are only permitted to perform the work described in the user manual. For other activities you must involve a competent installer. In case of questions or doubts, please contact your dealer.

The following symbols are used in the manual to indicate important information:



Work to be performed.



Tips and additional information.



Necessary instructions to prevent problems that might occur during installation and/or use.



Necessary instructions to prevent fire, personal injury or other serious damages.







2. Safety

2.1 Precautions / safety instructions

- Carefully read this section about safety and accurately observe the measures and instructions in this manual.
- 💡 The control unit of the appliance performs a safety check on the system every 24 hours. It is possible that this check is performed while the appliance is in operation. In that case, the appliance will extinguish and ignite again. Repetition at this particular time can be prevented by removing the plug from the socket and inserting it again at a time when the appliance is rarely or never burning.

2.1.1 Safety of the installation

- ⚠ The appliance is powered by 230VAC 50Hz.
- ⚠ Do not make any changes to the appliance.
- ⚠ If the appliance ignites with a thud, close the gas tap and contact your dealer.
- ⚠ In case of malfunctions and/or poor performance, close the gas tap and contact your dealer.
- ⚠ If the appliance does not ignite after three failed attempts, it is disabled for 30 minutes (hard lockout) to avoid dangerous accumulation of gas. Contact your dealer.

-  Never use the appliance in case of a broken or cracked glass pane. Close the gas tap and have the glass pane replaced.
-  Make sure that combustible objects and/or materials such as curtains have a distance from the appliance and/or the flues of at least 80cm, unless indicated otherwise in the installation manual.
-  Do not dry clothes, towels, etc. on and/or near the appliance, in order to prevent fire.
-  Avoid contact with hot parts of the appliance to prevent burns.
-  Make sure the control hatch is closed, in connection with the electrical voltage that is present.
-  If the appliance will not be used for an extended period of time, we recommend removing the batteries from the remote control in order to avoid damage resulting from leaking batteries.

2.1.2 Safety of people and animals

- ⚠ Do not leave children and persons who cannot judge the consequences of their actions alone with a burning appliance.
- ⚠ Place the remote control out of reach from children and persons who cannot properly judge the consequences of their actions.
- ⚠ Pets and birds in particular can be sensitive to the vapours that are released when heating for the first time. Keep the room well ventilated.
- ⚠ Only if supervised by an experienced person, or if instructions have been provided about how to operate the appliance and the accompanying safety risks, is it permitted to have the appliance operated by children from 8 years of age, persons with reduced physical, sensory or mental capacities and persons with lack of experience and knowledge.
- ⚠ Children should not play with the appliance.
- ⚠ Cleaning and user maintenance should not be performed by children without supervision.
- ⚠ The appliance may only be operated by means of the remote control and/or the DRU Fire App, provided the appliance is supervised.
- ⚠ In case of operation by means of the thermostat function, DRU Fire App or home automation system, the appliance may ignite without a direct ignition command. Take measures to prevent damage and unsafe situations in such cases.
- ⚠ If the DRU Fire App is used, measures should be taken to avoid hacking and thus unintended ignition of the appliance.

- ⚠ The appliance was designed for atmospheric and heating purposes. This means that all visible surfaces, including the glass pane, can become hotter than 100°C. It is recommended to always place a guard grille in front of the appliance when children, older people or persons with reduced physical, sensory or mental capacities are in the same room as the appliance. If these vulnerable people are regularly present in the room without supervision, a fixed guard should be made around the appliance.

2.1.3 Safety through maintenance

- ⚠ The appliance should be installed by a competent installer.
- ⚠ Your appliance should be maintained at least once per year by a competent installer.
- ⚠ Allow the glass pane(s) to cool down to room temperature prior to cleaning.
- ⚠ Contact your dealer for the safe and correct removal of the appliance.

2.2 EU Declaration of Conformity

We, DRU Verwarming B.V., hereby declare that the type of radio equipment 'Remote Control DRU RC BLE' is in accordance with Directive 2014/53/EU.

The full text of the EU Declaration of Conformity is available at the following internet address:
druservice.com

3. Taking the appliance in operation

Noises that occur while heating, cooling, adjusting the setting and burning the gas are part of the normal function of the appliance.

- ⚠ When starting the appliance, it is possible that condensation occurs on the inside of the glass pane(s). Once the appliance has reached its temperature, the condensation will disappear automatically.

3.1 Stoking up for the first time

- ⚠ - If the chimney breast is made of stone-like materials or has been finished in plaster, it should be left to dry for at least 6 weeks prior to taking it into operation.
- Prior to stoking up for the first time, clean the glass pane(s) (see section 6.1).
- Prior to taking into operation, the remote control should be coupled to the appliance (see section 4.3.2).
- ⚠ When the appliance is stoked up for the first time, the flame picture can be affected and an unpleasant smell may occur as volatile components evaporate. This process may take a number of hours.
 - Keep the room well ventilated.
 - Make sure there are no pets in the room.
- ⚠ Set the appliance to its highest level to speed up the evaporation process
- ⚠ Before and after stoking up for the first time, clean the glass panes according to the instruction to prevent contaminations from getting burned into the glass permanently (see section 6.1).

3.2 Discolouration of walls and ceilings

Discolouration of walls and ceilings can occur, for instance due to the combustion of dust as a result of too little ventilation, tar substances from tobacco smoke and soot formation as a result of burning atmospheric candles. The problems can be (partly) prevented by properly ventilating the room in which the appliance is located.

4. Operating the appliance

Several methods can be used to operate the appliance. These are described in the sections below.

4.1 DRU Fire App

The free DRU Fire App allows you to operate the appliance via the App. By means of the Eco Wave function, you are able to set two standard flame patterns and one individual flame pattern. This allows adjustment of the flame picture according to your own wishes and you can also determine the amount of gas you want to save yourself. If the stove malfunctions, the app will indicate the problem. The section 'Tips and tricks' provides useful information about the stove.

The DRU Fire App is available for both iOS and Android devices.



See section 4.3.2.3 for coupling the DRU Fire App to the appliance



4.2 Home automation

It is possible to control the appliance by means of a home automation system. Consult your dealer for the possibilities.



When the appliance is controlled by means of a home automation system, the operation can be taken over by the remote control and/or DRU Fire App at any time. After taking over from the remote control and/or App, the home automation system should be reset to the zero position to allow operation of the appliance with this system again.

4.3 Remote control

The appliance is supplied with a remote control. Its functions and possibilities are described in the following sections.

- 🔦 - The  symbol on the display of the remote control shows the current status of the connection with the appliance:
 - Not visible: No connection with the appliance
 - Flashing: Looking for connection with the appliance
 - Visible: Connected with the appliance

4.3.1 Placing/replacing the batteries

The remote control works with two AA alkaline batteries. When the  symbol lights up on the display, the batteries should be replaced.

- 🔦 - It is not possible to use rechargeable batteries.
- If the batteries are completely empty, the display will go blank. Replace the batteries of the remote control in time. Timely replacement of the batteries also prevents possible damage to the electronic components due to leaking batteries.

Place and replace the batteries as follows:

- Remove the cover from the battery compartment by pushing it down lightly and sliding it off the remote control (see fig. 4-1, 1).
- Remove the old batteries from the holder (see fig. 4-1, 2).
- Place the new batteries in the holder (see fig. 4-1, 2).
- 🔦 The correct orientation of the batteries to be placed is shown on the inside of the battery compartment.
- Place the cover, slide it upwards and allow it to snap tight to lock (see fig. 4-1, 3).
- ⚠ Hand in the batteries at the collection point intended for this purpose.

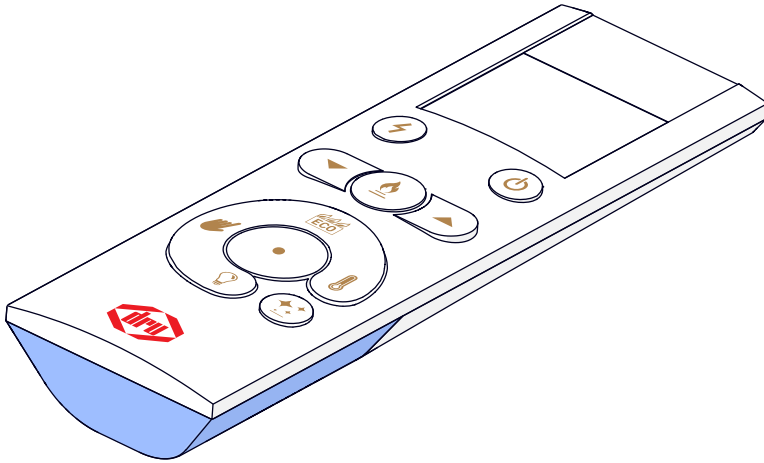

1

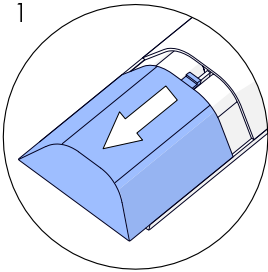

2

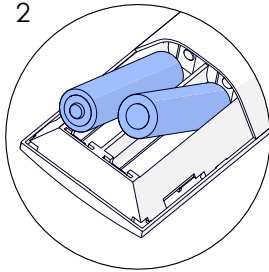

3

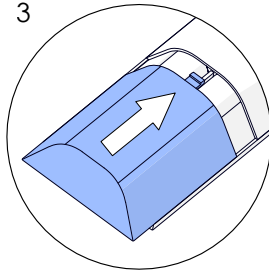

4-1

38C-2780

4.3.2 Coupling the remote control

Before you can use the remote control, it must be coupled with the appliance. The remote control can only be coupled when it is in the *bnd* (see fig. 4-3) mode. Observe the following steps to couple the remote control.

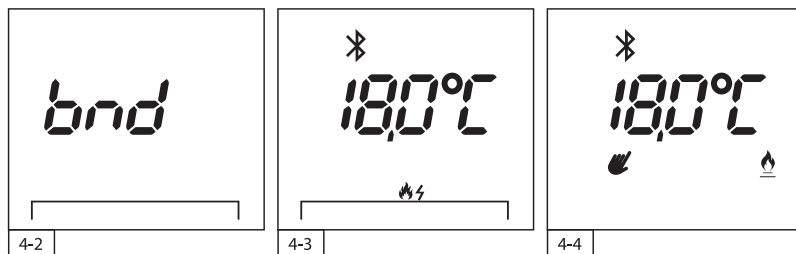

- The display of the remote control shows the message *bnd* (see fig. 4-2). If this is not the case, see section 4.3.3.
- Make the appliance free from voltage by removing the plug from the appliance control unit (see fig. 4-5).
- 💡 The control hatch (if applicable) can be opened and closed by means of a coin or a flat screwdriver.
- Wait 5 seconds and insert the plug in the appliance control unit again.
- 💡 For 5 minutes, it will now be possible to couple the remote control with the appliance.
- Press buttons ⚡ and 🖱 simultaneously for 1 second.
- When coupling has been successful, the ⚡ symbol will light up continuously and the current room temperature and possibility of ignition are shown (see fig. 4-3).

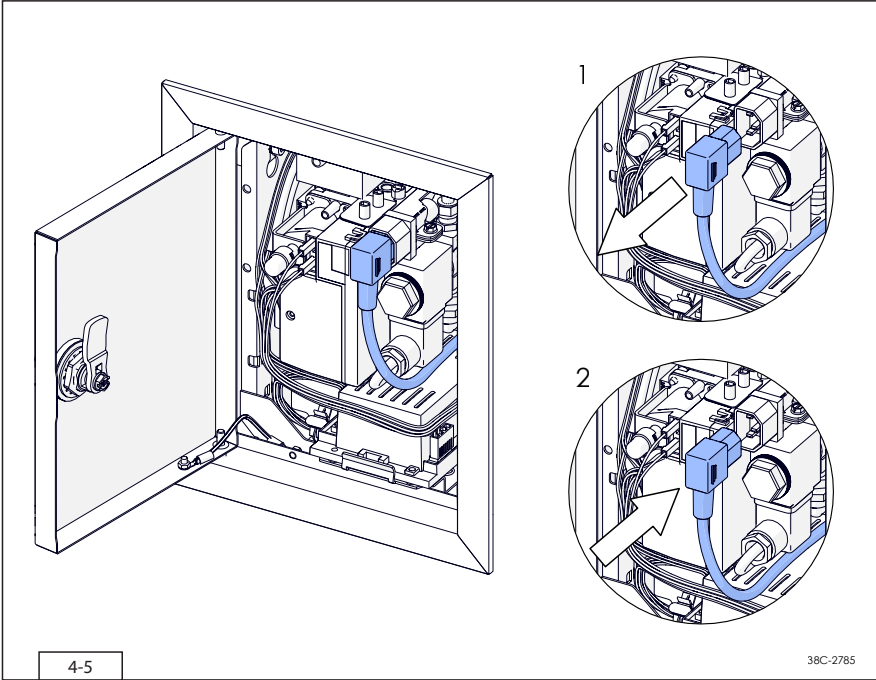

4.3.3 Uncoupling the remote control

Observe the steps below for uncoupling the remote control from the appliance:

- Make sure the appliance is free from voltage by removing the plug from the appliance control unit (see fig. 4-5). After 30 seconds, the message *LOS t* is shown on the display.
- Press buttons ⚡ and ● simultaneously for 3 seconds.
- Now the message *brd* is shown on the display. The remote control is now uncoupled from the appliance.
- For coupling the remote control (again), see section 4.3.2.

4.3.4 Coupling the DRU Fire App

Observe the steps below for coupling the DRU Fire App with the appliance.

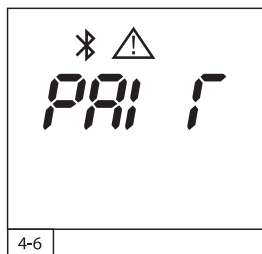







- ⚙ Before the appliance can be coupled with the DRU Fire App, the remote control must be coupled with the appliance (see section 4.3.2).
- Download the DRU Fire App (see section 4.1)
- If the appliance is being used, switch off the appliance by means of the remote control.
- Observe the instructions in the DRU Fire App.

4.3.5 Switching off the appliance

The appliance can be switched off by pressing the  button. The appliance will switch off immediately.





4.3.6 Ignition +

Observe the step below to ignite the appliance.

- Press buttons  and  simultaneously. The appliance will immediately start with the ignition cycle.
-  During the ignition cycle, the  symbol will flash on the display.
- ⚠ The main burner will be ignited at 50%. If a flame is detected, the appliance will switch to full capacity. Then the second burner will be ignited (if applicable). Once the ignition cycle has been completed, the flame height can be adjusted according to your own wishes (see fig. 4-7).
- ⚠ - In case of an appliance that works on propane: after switching off the appliance, a waiting time of 5 minutes applies before the appliance can be ignited again.
- If the appliance does not ignite after three failed attempts, it is disabled for 30 minutes (hard lockout) to avoid dangerous accumulation of gas. Contact your dealer.
-  In case of a PowerVent® system, it may take some time before the appliance ignites due to the start-up of this system. During the start-up process of the system and ignition of the appliance, the  symbol will flash on the display. Consult the PowerVent® manual for more information.

4.3.7 Switching on/off the second burner

If the appliance has a second burner, it can be switched on and off with the remote control.

- The second burner can be switched on and off by pressing the  button. When switching on, the  symbol is shown on the display (see fig. 4-7). By pressing the button  once more, the second burner is switched off. The  symbol disappears from the display.
-  - A click sound can be heard before the second burner is ignited.
- When switching on the second burner, the appliance first switches to the full position to ensure correct ignition, after which it returns to the previously set position.

4.3.8 Manual operation





By means of manual operation it is possible to adjust the flame height manually in 10 steps from 1 (minimum) to 100 (maximum). To adjust the flame height, proceed as follows:



4-7



4-8

- Press the  button to activate manual operation. The  symbol is shown on the display (see fig. 4-7).
- Use buttons  and  to adjust the required flame height. For a few seconds, the adjusted flame height remains visible on the display (see fig. 4-8), after which the remote control returns to the main screen (see fig. 4-7).
- ⚙️ When the second burner (if applicable) is switched off, 100 (maximum) is identical to the maximum capacity of the main burner.
- The flame height can be adjusted at any time by repeating the steps described above.
- ⚠️ If a time schedule is active and the appliance is switched on manually, the appliance will change its settings according to the time schedule in the event of a scheduled switch in the time schedule.

4.3.9 Eco Wave

Eco Wave allows you to vary the height of the flame picture automatically and continuously. Eco Wave saves energy and provides a dynamic flame picture.





4-9

- Switch on the Eco Wave mode by pressing the  button (see fig. 4-9).
- 🔦
 - In the DRU Fire App, it is possible to make a selection from various pre-programmed flame patterns. It is also possible to configure your own flame patterns according to your own preferences (see section 4.1).
 - If the DRU Fire App is not being used, the standard loaded Eco Wave programme will be used.
 - When Eco Wave is switched on, the flame height cannot be adjusted manually.
 - When the second burner (if applicable) is switched off, the Eco Wave programme is only performed with the main burner.
- ⚠ If a time schedule is active and the appliance is switched on manually, the appliance will change its settings according to the time schedule in the event of a scheduled switch in the time schedule.

4.3.10 Thermostat

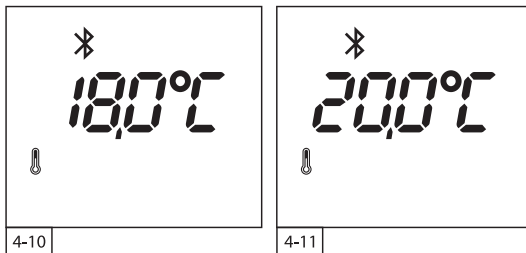
By means of the thermostat function, the flame height is adjusted automatically based on the required room temperature.



- Switch on the thermostat by pressing the  button (see fig. 4-10).
- Use buttons ▲ and ▼ to select the required temperature.
- 🔦 The temperature can be set between 5.0 and 35.0 °C.
- For a few seconds, the programmed temperature remains visible on the display (see fig. 4-11).
- The remote control then returns to the main screen. The current room temperature is shown (see fig. 4-10).

- ⚠ Make sure the remote control is in the same room as the appliance.
 - 🔦 - The remote control contains a temperature sensor. Therefore, always place it on a fixed, draught-free location with no direct sunlight.
 - When the second burner (if applicable) is switched off, only the main burner is being controlled.
 - When the set temperature has been reached, the appliance switches off.

- ⚠ If a time schedule is active and the appliance is switched on manually, the appliance will change its settings according to the time schedule in the event of a scheduled switch in the time schedule.

4.3.11 Eco Glow / Switch contact ✨

With this function, it is possible to switch the Eco Glow glow lighting (if applicable) on and off.

It is possible that the appliance is not equipped with Eco Glow glow lighting, but that the button on the remote control has been given a function. For example: the installer has used the switch contact for chimney breast lighting or a chimney breast fan.



4-12

- Switch the Eco Glow glow lighting on/off by pressing the ✨ button. The ✨ symbol appears/disappears on/from the display (see fig. 4-12).
- 🔦 - It is possible to switch on the Eco Glow glow lighting without the burner(s) being used.
- It is possible that this function is not connected. In that case, this button will not have a function.

4.3.12 Switching power supply 💡

The switching power supply is a function that makes it possible to switch on an extra appliance. The switching power supply can only be switched on and off with the remote control. Via the DRU Fire App, it is also possible to dim it.

- Switch the switching power supply on/off by pressing the 💡 button.
- ⚠ When switching on, no symbol will appear on the display.
- 🔦 It is possible to switch on the Switching power supply without the burner(s) being used.

4.3.13 Time Schedule



The time schedule must be set by means of the DRU Fire App. If a time schedule is active, the  symbol is shown on the display of the remote control.

Each day, a maximum of three different periods can be set. The following time schedules are possible:

- A time schedule with the same settings for each day.
- A time schedule with separate settings for the week days (Monday to Friday) and the weekend.
- A time schedule with separate settings for each day.

It is possible to switch the set time schedule on and off manually, by means of the remote control:



Press buttons  and  simultaneously for a few seconds. When switching on, the  symbol is shown on the display and when switching off it will disappear (see fig. 4-13 and 4-14).

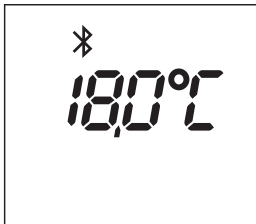



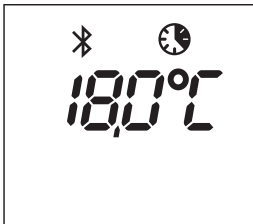



4-13



4-14

4.3.14 Temperature display in degrees Celsius or Fahrenheit

The standard temperature display is in degrees Celsius. It is possible to change the temperature display between Celsius and Fahrenheit. Observe the following steps to do this:

- Switch off the appliance  if it is operating.
- Hold down the  and  buttons for 3 seconds.
- The display shows the currently selected temperature unit. Use buttons  /  to select the required temperature unit (see fig. 4-15 and 4-16).
- Wait 5 seconds or press the  button to confirm your selection.

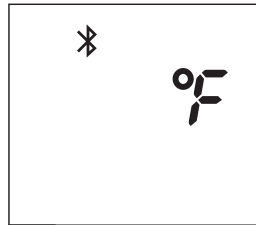
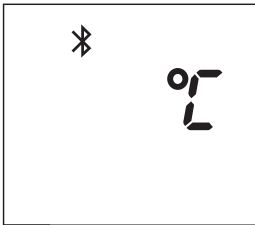

4.3.15 Updating the remote control

It is possible to provide the remote control with a software update, if such an update is available. To be able to perform this update, use of the DRU Fire App is required (see section 4.1).

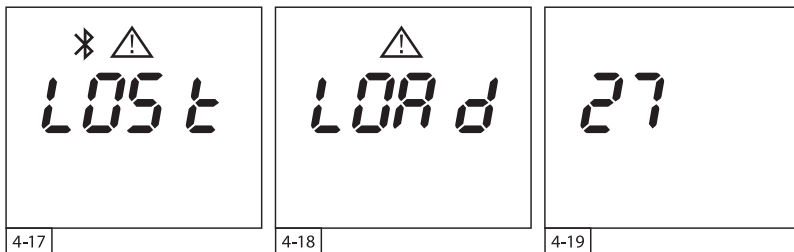

- Proceed as follows to provide the remote control with an update:
- ⚠ Make sure the batteries in the remote control have sufficient power and are not removed during the update process.
 - Make the appliance free from voltage (see fig. 4-5). After 30 seconds, the display shows *LOS t* (see fig. 4-17).
 - Hold down buttons ● and 💡 for 10 seconds.
 - The display shows the message *LOR d* (see fig. 4-18).
 - Now, you are able to start the update process in the DRU Fire App. Observe the steps in the App.
- 🔧
- If there is no activity within a period of 20 seconds, the remote control returns to the main screen.
 - To find the version number of the software on the remote control, first remove the batteries from the remote control. When the batteries are placed back, the version number is shown on the display for 3 seconds (see fig. 4-19).

5. Malfunction

5.1 Error message *LOSt*

The remote control has lost its connection with the appliance. This could have several causes:

- The remote control is too far removed from the appliance. Bring the remote control nearer to the appliance.
- The appliance is free from voltage. Restore the voltage to the appliance.

If the signal is lost, the remote control will show an empty screen with an hourglass for the first 30 seconds (see fig. 5-1). If the signal is lost for more than 30 seconds, the error message *LOSt* will appear and the Bluetooth symbol will flash on the display (see fig. 5-2).



During the above-mentioned message, the remote control continues to search for the appliance and the connection is restored when the appliance and remote control are within each other's reach again.

If the signal is lost for more than 1 minute, the remote control will stop searching for the appliance (see fig. 5-3).



When a random button is pressed, the remote control will try to restore the connection between the appliance and the remote control for 1 minute.

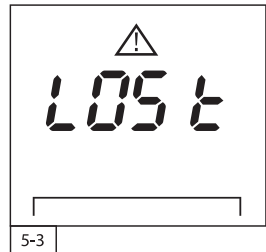
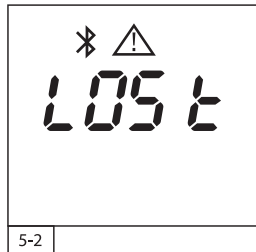
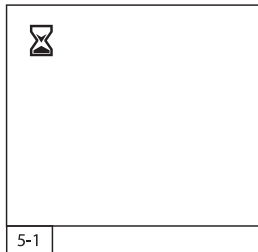

5.2 Measuring the strength of the signal

It is possible to measure the received signal strength from the appliance on the remote control. A good signal strength is between -20dB and -70dB , a poor signal strength is below -70dB . Proceed as follows to check the signal strength:

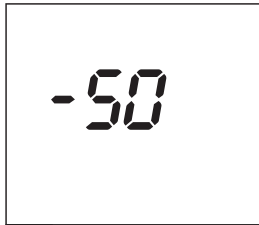

5-4

- Hold down the ● and  buttons for 5 seconds.
- The display shows the currently measured signal strength.
- 💡 After 10 seconds, the display automatically returns to the main screen. Each press on a random button extends this function by 10 seconds.

5.3 Error code F/E

In case of a malfunction of the appliance, the remote control will show an error code as well as the warning and reset symbol. The error codes are indicated by means of an F and an E, combined with a two-digit code.

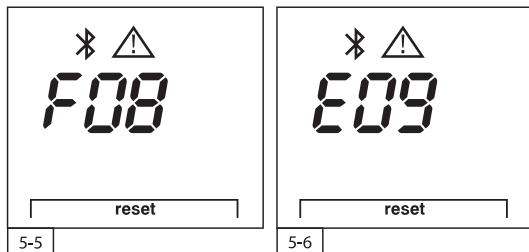

- It is possible that an F and an E error code are active simultaneously. In that case, these will be shown alternately every 3 seconds.
- If the DRU Fire App is used, it is possible to send the error code(s) plus extra information to your dealer. See the App for more information.

5.4 Resetting the appliance

When the appliance malfunctions, it cannot be used and should be reset (see fig. 5-5 and 5-6).



Press the ⚡ and ⏻ buttons simultaneously for one second to reset the device.



- If the appliance does not ignite after three failed attempts, it is disabled for 30 minutes (hard lockout) to avoid dangerous accumulation of gas. Contact your dealer.
- Contact your dealer if malfunctions occur repeatedly and/or return.

6. Maintenance

At least once per year, the appliance should be checked for proper and safe operation.

- ⚠ - Your appliance should only be maintained by a competent installer.
- In case of a cracked or broken glass pane, do not use the appliance and close the gas tap. Have the glass pane replaced immediately.
- Do not make any changes to the appliance yourself.

- ⚠ - Do not use corrosive or abrasive detergents when cleaning.
- Unpainted stainless steel parts can be cleaned with water, a soft cloth and, if necessary, a mild detergent. Aggressive detergents (such as chlorinated or abrasive detergents) could lead to corrosion and/or dull spots.

6.1 Cleaning the glass pane(s)

Contaminations that have settled on the glass panes could burn in permanently. To prevent this, clean the glass panes with the DRU glass cleaner set, consisting of the DRU Spray, DRU glass pane cleaner, a pair of cotton gloves and two microfibre cloths.

Have the glass pane(s) cleaned on the inside once per year by a competent installer, to prevent contaminations from burning into the glass. If the appliance is equipped with an Easy release door system, it is also possible to clean it on the inside yourself (see section 6.1.1).



Due to circumstances, it is possible that the glass pane(s) must be cleaned on the inside more often than once per year.



- Avoid damage to the glass pane(s).
- Avoid/remove fingerprints on the glass pane(s), as they will burn into the glass.
- Use the cotton gloves from the glass cleaner set during the cleaning process in order to prevent the introduction of new fingerprints.
- Only use the DRU Glass Cleaner. It is available via your dealer
- Only use a microfibre cloth when cleaning. Other materials such as (kitchen) paper and steel wool could cause scratches in the paint and the coating of the anti-reflective glass pane(s).
- Regularly remove accumulated dirt, as it can burn into the glass.

6.1.1 Easy release door system

An Easy release door system allows you to open the appliance yourself, so that the glass pane can be cleaned on the inside. The installation manual describes how this is done.

- ⚠ The appliance must be switched off and must be at room temperature, before it may be opened and cleaned.

During production, transport and installation, it is possible that dust gets on the glass pane(s) and is burned into the glass when taken into operation. Clean the glass pane(s) before the appliance is taken into operation.

- Clean the glass pane(s) on both sides with DRU spray and DRU glass pane cleaner (see sections 6.2 and 6.3)

When stoking up for the first time, contaminations are released that may settle on the glass pane(s) as a white deposit. Observe the steps below to prevent this deposit from burning into the glass:

- Clean the glass pane(s) on both sides with DRU glass pane cleaner (see section 6.3)
- Regularly clean the glass pane(s) on both sides with DRU glass pane cleaner when deposits are visible (see section 6.3).

- 💡 Gas contains certain components in changing concentrations that could cause a white deposit on the glass pane(s). This cannot be prevented and DRU cannot be held responsible for this.

6.2 How to use DRU spray

- Apply the DRU spray directly on the glass pane.
- Wipe the glass pane fully clean and dry with a clean microfibre cloth.

6.3 How to use DRU glass pane cleaner

- ⚠ Properly shake the glass pane cleaner prior to use.
- Apply a limited amount of DRU glass pane cleaner to a slightly damp microfibre cloth.
- Rub DRU glass pane cleaner over the whole glass pane(s).
- After waiting for a few minutes, wipe the glass pane fully dry with a clean and dry microfibre cloth.
- Repeat the above-mentioned steps in case of stubborn deposits.
If necessary, you can exert more pressure to remove the contamination.

7. Environment

7.1 General

Packaging materials should be disposed of via the waste streams intended for that purpose.

- ⚠ Do not throw empty batteries away as residual waste, but hand them in at the collection point intended for that purpose.

7.2 Appliance

The appliance should be processed in a responsible method intended for that purpose.

- ⚠ Do not place the appliance with unsorted waste, but bring it to a collection point intended for that purpose.
- 🔌 Contact your council for information about the available collection streams.

8. Warranty

The factory warranty is valid for 2 years after date of purchase. Damages to the paint, resulting from objects fallen/placed on or against the appliance are not covered by the warranty.

The warranty for your DRU appliance will be provided via your dealer. Contact your dealer in case of questions and/or complaints.

9. Technical data Remote control

Batteries: 2x AA (Rechargeable batteries not possible)

Transmit power: <20mW (<13dBm)

Transmission Frequency: 2402-2480MHz



DRU Verwarming B.V.
The Netherlands

Postbus 1021, NL-6920 BA Duiven
Ratio 8, NL-6921 RW Duiven
